

# Dispermill X-Proof FR220



Laboratory Dissolver

The Dispermill X-Proof FR220 is designed to operate in potentially explosive atmospheres. The design is not only about safety but also about usability and performance. The height is easily adjustable with the ergonomic lever in combination with the counterweight. Besides, the dissolver is equipped with a control panel that is comfortable to operate and a clear blue screen for readout of the RPM. The powerful motor maintains its selected speed, independent of changes in viscosity and this guarantees an optimum dispersion process.

## SAFETY FIRST

Your safety is very important to us. That's why we developed safety interlocks for vessel detection and operation height. So you can focus on your activities without being worried about any hazards. The X-Proof FR220 meets the latest ATEX safety requirements.

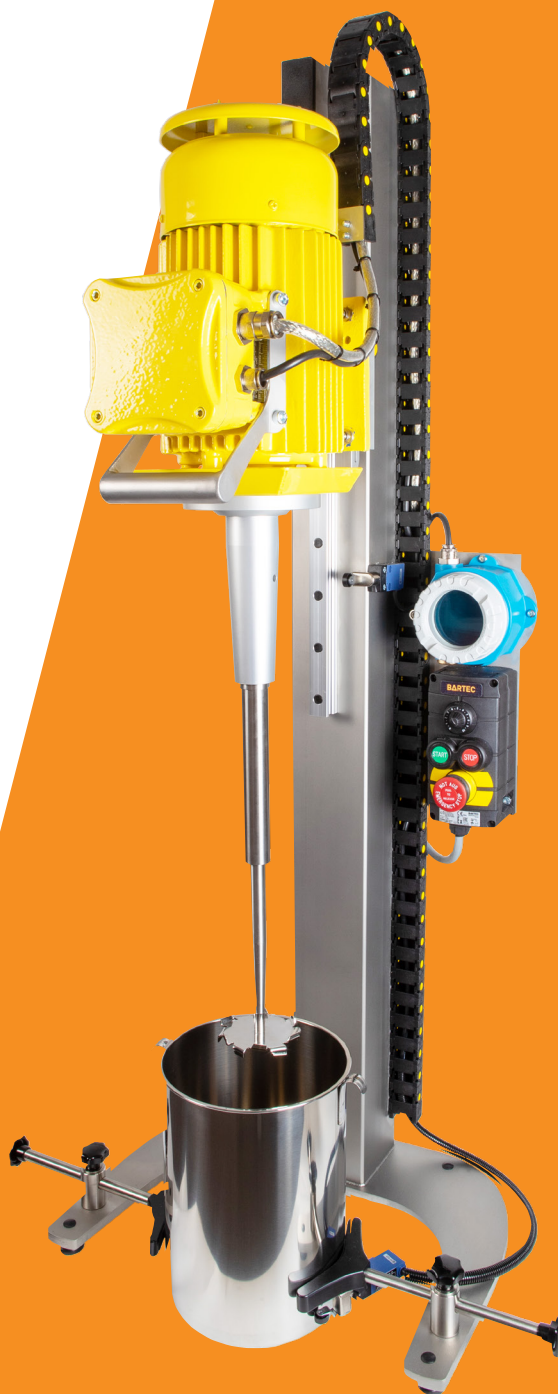

## FEATURES

- ✓ Clear blue display for readout RPM
- ✓ Timer 1 min - 120 min with auto stop (optional)
- ✓ ABB Electronics
- ✓ Stainless steel design
- ✓ 90 mm dispersing disc included

**X-Proof FR220**

2,2 kW, 250 - 4.000 RPM, 1 - 25L

**Order code**

10-1046

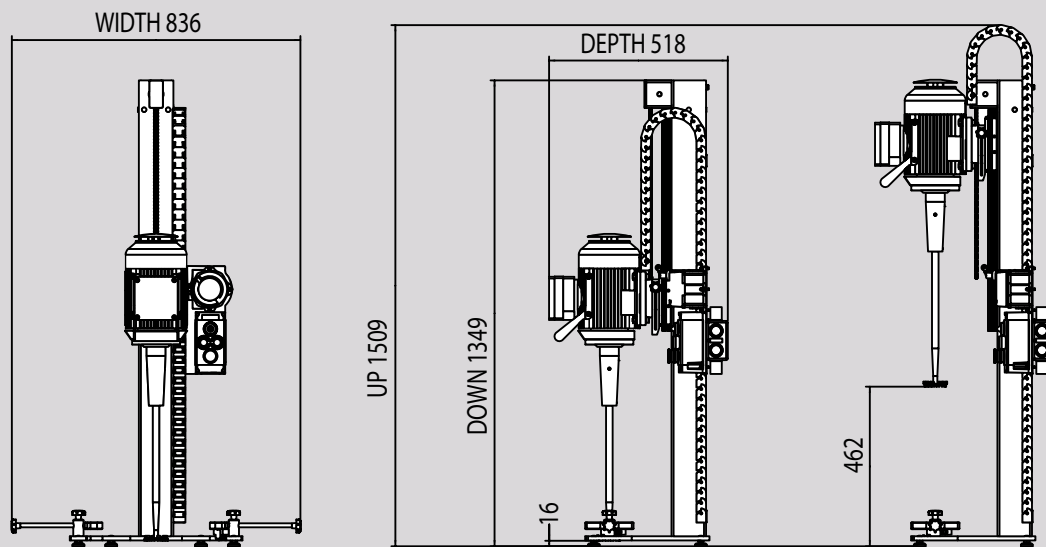

## TECHNICAL SPECIFICATIONS

<b>Power</b>	2,2 kW / 3 HP
<b>Supply</b>	400 V +/- 10% 50/60Hz, 16 Ampere
<b>Speed</b>	250 till 4.000 RPM
<b>Thermal protection</b>	PTC Temperature sensors
<b>Volume range vessel</b>	1L - 25L
<b>Diameter vessel</b>	70 - 305 mm (min. - max.)
<b>Height vessel</b>	75 - 450 mm (min. - max.)
<b>Dispersing disc</b>	90 mm (interchangeable)
<b>Dimensions (in mm)</b>	518 x 836 x 1349/1509 (D x W x H)
<b>Weight</b>	+/- 70 KG
<b>Readout</b>	True shaft speed on clear blue display
<b>Protection class</b>	 II2G IIB T3
<b>Safety CE</b>	Conformity Directive 2006/42/EC
<b>Electrical cabinet</b>	Dimensions: 500 x 400 x 210 mm. Requires placement outside of ATEX zone.

## OPTIONS



Dual spindle clamping  
(+031)

- +015 Power readout in kW
- +011 Mechanical timer with automatic stop (120 min)